

Important points on service, and flow chart for inspecting and repairing the unit.....	1
Appearance	2
Troubleshooting.....	3
Operation.....	4-5
Remote control.....	6-7
Technical specifications.....	8-9
Refrigerator system diagram	10
Schematic wiring diagram	11
Exploded view and parts list	12-17

This manual is for the use of technical personnel entrusted with maintenance.

Widetech reserves the right to change this dehumidifier's casing, circuit and parts without notice.

115V / 60Hz

Date : 2007/04/27

Version : 1.0

IMPORTANT POINTS ON SERVICE OPERATING SAFETY

Please follow these instructions carefully:

- Unplug the unit to avoid any danger from electric shock before disassembling the unit for repair.
- If there is any sound of the refrigerant circulating when in operation, avoid touching the cooling coils.
- If you need to perform any welding or soldering, be sure you are in a well ventilated area.
- Only a qualified professional should perform any welding on the unit.
- When repairing the unit, the specifications listed in this manual must be strictly adhered to when replacing any components.
- When replacing any electrical components they should be factory approved units.
- Be sure that any electrical components are properly wired and in place.

FLOW CHART FOR INSPECTING AND REPAIRING THE UNIT

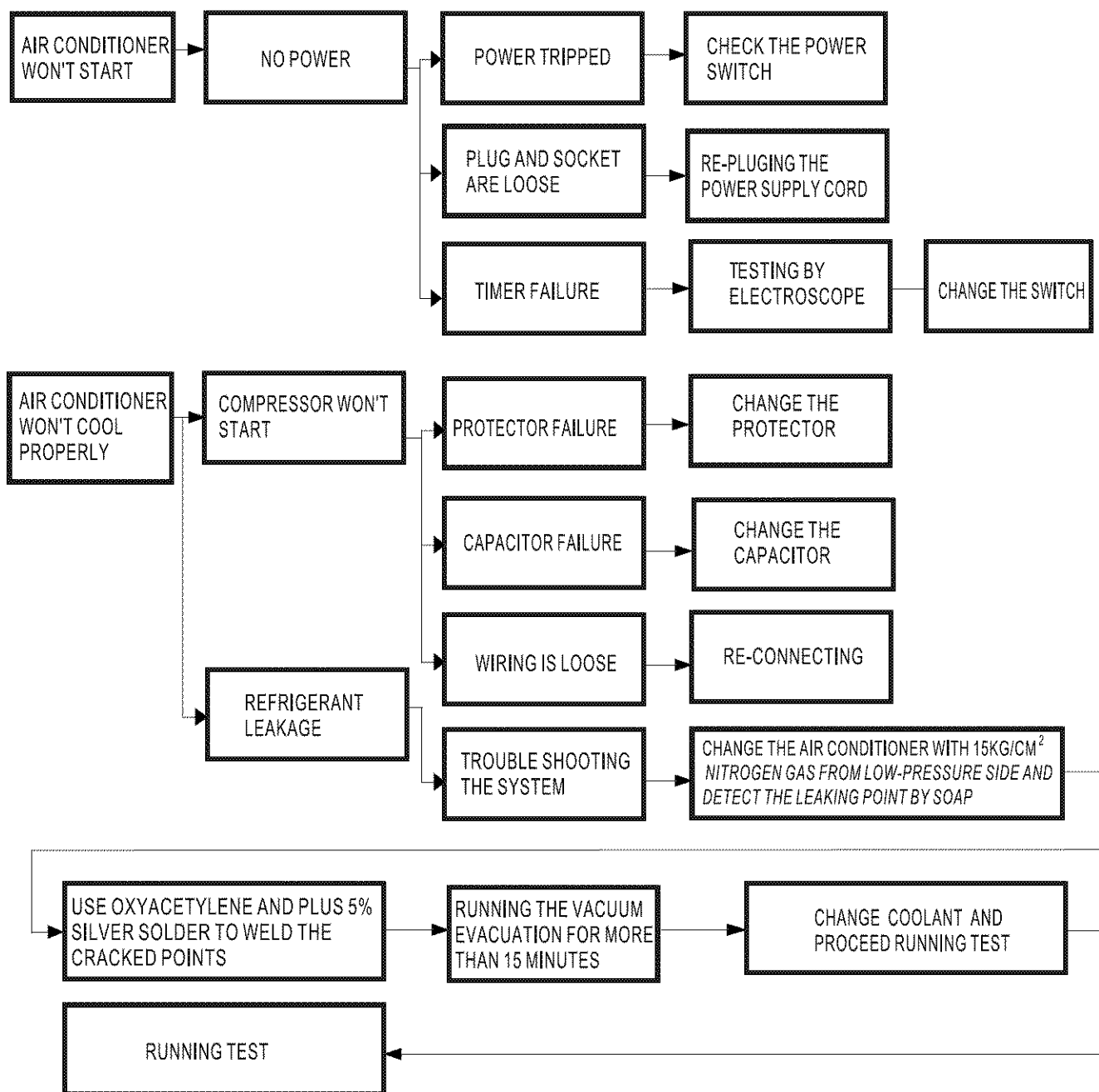

APPEARANCE

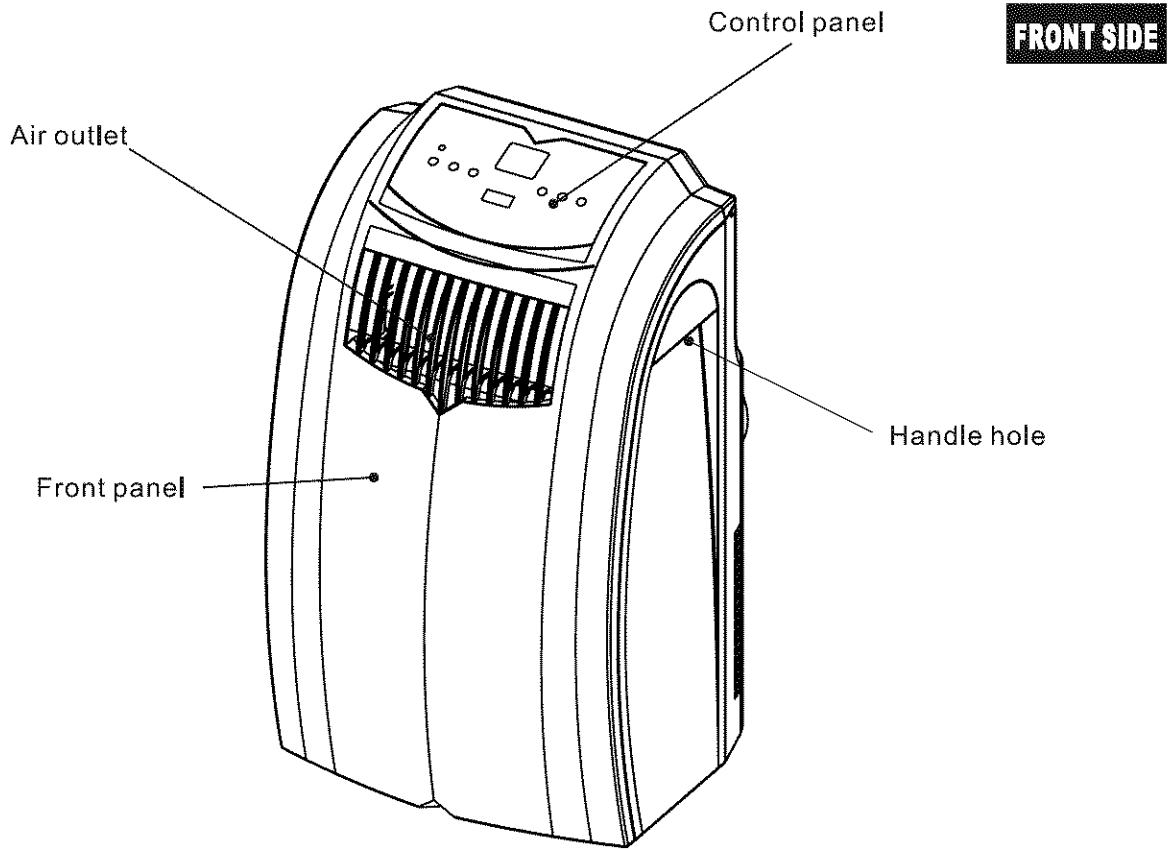

APPEARANCE

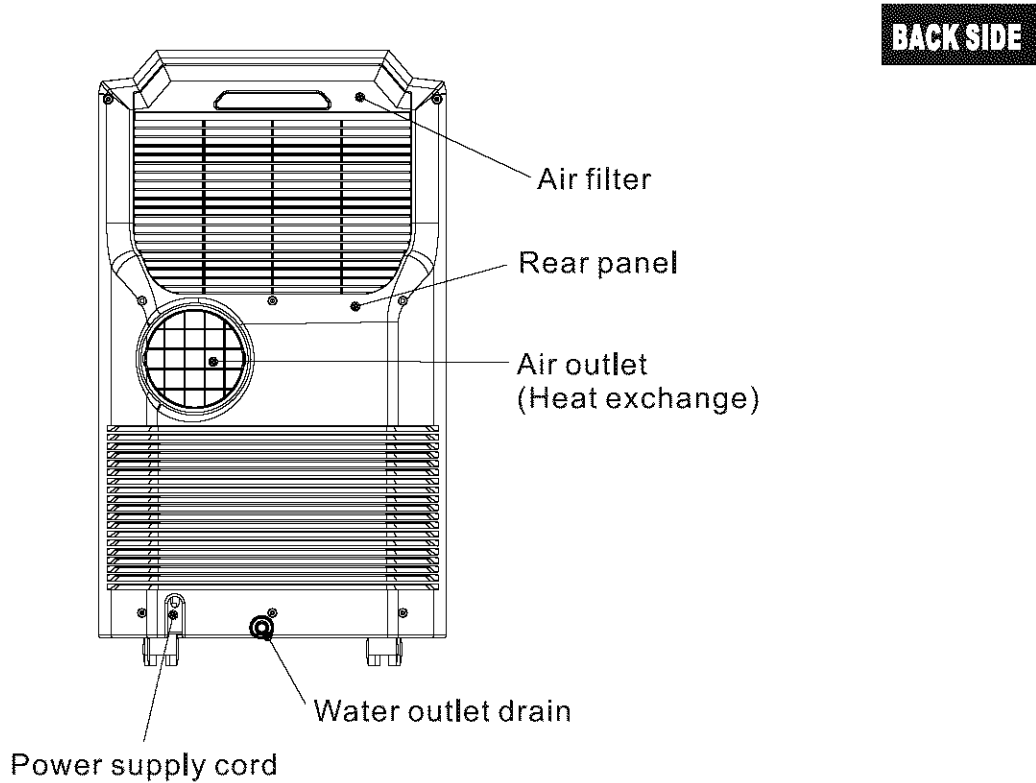





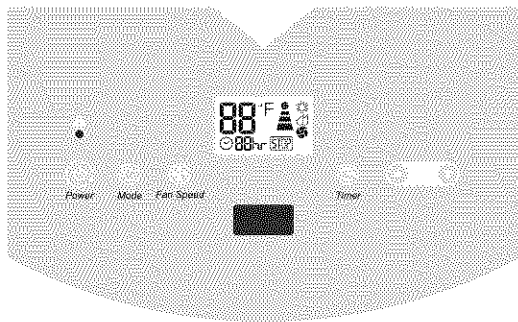



TROUBLESHOOTING

Trouble	Analysis
Does not run	<ul style="list-style-type: none">· If the protector trip or fuse is blown.· Please wait for 3 minutes and start again, protector device may be preventing unit to work.· If batteries in the remote controller exhausted.· If the plug is not properly plugged.
Run a short while only	<ul style="list-style-type: none">· If the set temperature is close to room temperature, you can low the set temperature.· Air outlet be blocked by obstacle. Take the obstacle away.
Run but not cool	<ul style="list-style-type: none">· If the door or window open.· If there is other heater appliance work, like heater or lamp, etc...· The air filter is dirty, please clean it.· Air outlet or intake be blocked.· Set temperature is too high.
Do not run and water full indicator lights	<ul style="list-style-type: none">· Drain the water into a prepared container by the drainage pipe on the rear panel of the unit. If still doesn't work, please consult a qualified technician.



Indication symbols on LCD :

-  Cooling mode
-  Dehumidify mode
-  Fan only mode
-  Display set temperature
-  Warning light the machine will stop running
-  Display timer setting of auto switch on/off
-  High fan speed
-  Med fan speed
-  Low fan speed

Power Control

The power control turns the unit on and off.

Warning Light

Condensed water may accumulate in the unit. If the internal tank becomes full, the Warning signal in the LCD Display will light up and the unit will not operate until the unit has been drained.

Mode Control

The Mode Control has 4 settings:

- Cool
- Dehumidify
- Fan
- Heating

The settings are adjusted with Mode Control button. A light will indicate which setting is currently being used.

● Cooling Mode

When cool mode is selected, "☀" will show in the LCD Display. During the cooling mode the air is cooled and hot air is exhausted to the outside through the exhaust tube. Adjust fan speed and air temperature to suit your desired comfort level.

Note : The air exchange hoses must vent outside the room when using cool mode.

● Dehumidify Mode

When Dehumidify mode is selected, "☁" will show in the LCD Display. Air is dehumidified as it passes through the unit, without being in full cooling mode. If room temperature is higher than 25 degree Celsius, fan speed can be adjusted; otherwise fan speed is fixed to "Low".

Note : If the unit is to be used as a dehumidifier, do not connect the exhaust hose let the warm air return to the room. Continuous drainage is then necessary.

● Fan Mode

When fan mode is selected, "☁", "☁" or "☁" will be shown in the LCD Display. Air is circulated throughout the room with no cooling.

Note: unit does not need to be vented in Fan mode

Fan Speed Control

The Fan Speed Control has 3 settings: High, Medium, and Low.

Timer

Auto turn off :

With machine in running mode, press timer button for setting timer control. Press "▲" or "▼" to select number of hours you would like the unit to run before it automatically shuts off.

Auto turn on :

With machine in stand by mode, press timer button for setting timer control. Press "▲" or "▼" to select number of hours before the unit automatically starts running in airconditioning mode.

Note : The time is adjustable between 1~24 hours.

Temperature controls

- Used for adjusting the thermostat.
 - The default display is room temperature.
 - In cooling mode, when "▲" or "▼" button is pressed, the set temperature is displayed and may be adjusted. After 15 seconds the display will revert back to room temperature. Temperature is only adjustable in cool mode.
- Note : By pressing both "▲" / "▼" buttons at the same time for more than 3 seconds, the display will toggle between Celsius and Fahrenheit.**

After switching the air conditioner off, you must wait 3 minutes before switching it back on again.

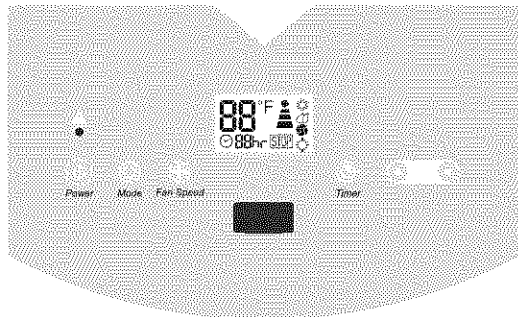

Indication symbols on LCD :

- | | | | |
|--|--|--|----------------|
| | Cooling mode | | High fan speed |
| | Dehumidify mode | | Med fan speed |
| | Fan only mode | | Low fan speed |
| | Heating mode | | |
| | Display set temperature | | |
| | Warning light
the machine will stop running | | |
| | Display timer setting of auto switch on/off | | |

Power Control

The power control turns the unit on and off.

Warning Light

Condensed water may accumulate in the unit. If the internal tank becomes full, the Warning signal in the LCD Display will light up and the unit will not operate until the unit has been drained.

Mode Control

The Mode Control has 4 settings:

- Cool ● Dehumidify ● Fan ● Heating

The settings are adjusted with Mode Control button. A light will indicate which setting is currently being used.

● Cooling Mode

When cool mode is selected, "" will show in the LCD Display. During the cooling mode the air is cooled and hot air is exhausted to the outside through the exhaust tube. Adjust fan speed and air temperature to suit your desired comfort level.

Note : The air exchange hoses must vent outside the room when using cool mode.

● Dehumidify Mode

When Dehumidify mode is selected, "" will show in the LCD Display. Air is dehumidified as it passes through the unit, without being in full cooling mode. If room temperature is higher than 25 degree Celsius, fan speed can be adjusted; otherwise fan speed is fixed to "Low".

Note : If the unit is to be used as a dehumidifier, do not connect the exhaust hose let the warm air return to the room. Continuous drainage is then necessary.

● Fan Mode

When fan mode is selected, "", "" or "" will be shown in the LCD Display. Air is circulated throughout the room with no cooling.

Note: unit does not need to be vented in Fan mode

● Heating Mode

When heating mode is selected, "" will show in the LCD Display. Heating is activated only when the ambient temperature is below 27°C. In this mode, the desired temperature can be set between 16 and 27°C.

Note: When the device is in heating mode, both air hoses must be connected and led outside.

Fan Speed Control

The Fan Speed Control has 3 settings: High, Medium, and Low.

Timer

Auto turn off :

With machine in running mode, press timer button for setting timer control. Press "" or "" to select number of hours you would like the unit to run before it automatically shuts off.

Auto turn on :

With machine in stand by mode, press timer button for setting timer control. Press "" or "" to select number of hours before the unit automatically starts running in airconditioning mode.

Note : The time is adjustable between 1~24 hours.

Temperature controls

- Used for adjusting the thermostat.
 - The default display is room temperature.
 - In cooling mode, when "" or "" button is pressed, the set temperature is displayed and may be adjusted. After 15 seconds the display will revert back to room temperature. Temperature is only adjustable in cool mode.
- Note : By pressing both "" / "" buttons at the same time for more than 3 seconds, the display will toggle between Celsius and Fahrenheit.**

After switching the air conditioner off, you must wait 3 minutes before switching it back on again.

Air Conditioner Remote Control

The functions work the same as your air conditioner's touch controls. All key function can be accessed from the remote control.

CONTROL PANEL

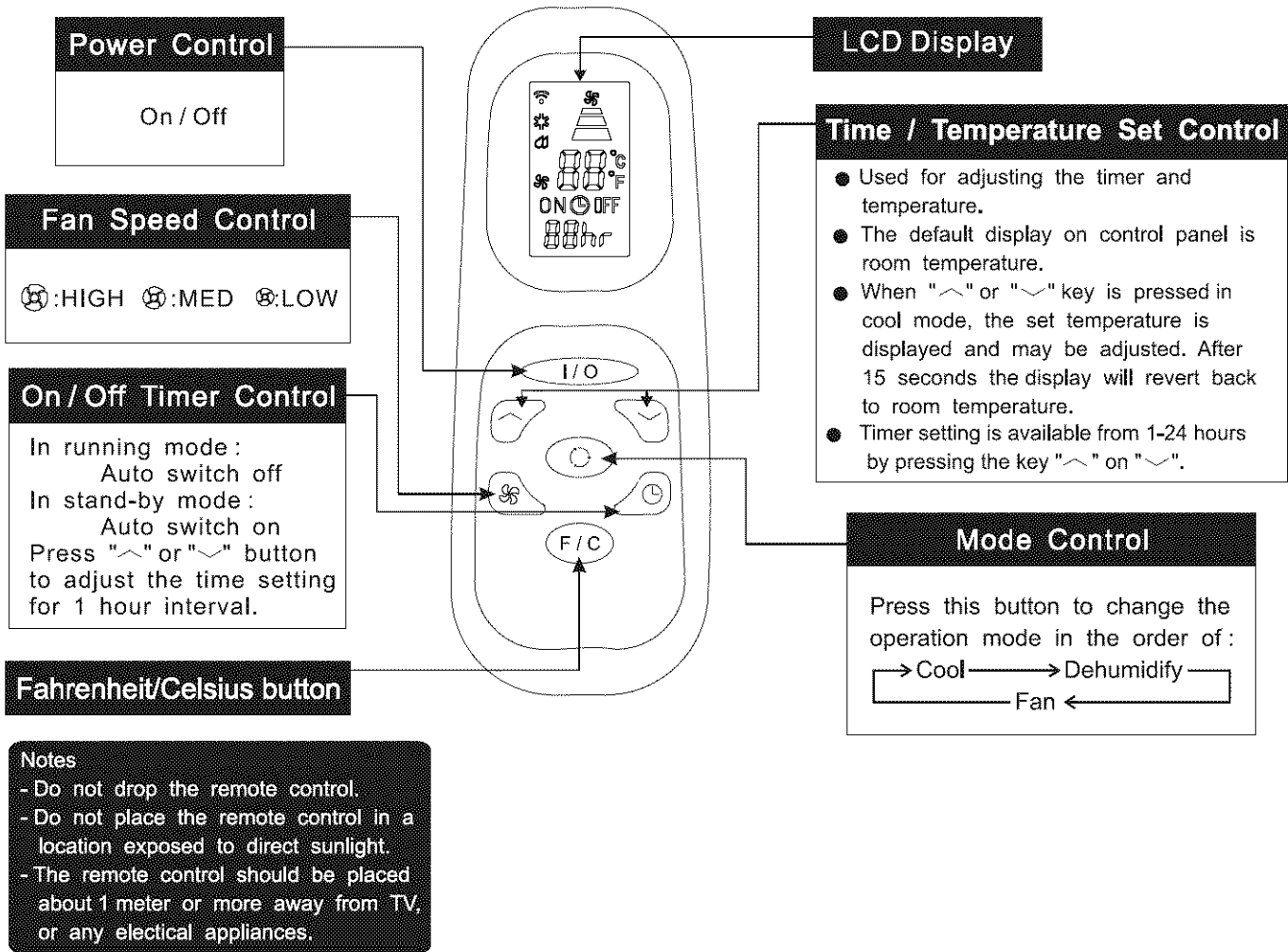

Battery replacement : Remove the cover on the back of the remote control and insert the batteries with the (+) and (-) poles pointing in the proper direction.

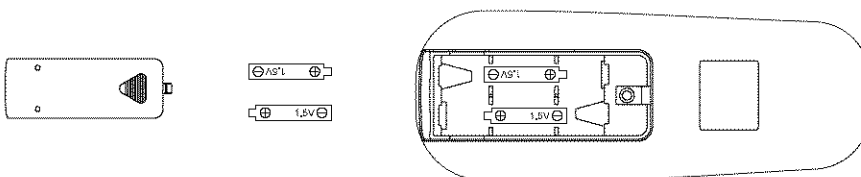

CAUTION

- Use only AAA or IEC R03 1.5V batteries.
- Remove the batteries if the remote control is not used for a month or longer.
- Do not attempt to recharge the supplied batteries.
- All batteries should be replaced at the same time, do not mix old battery .
- Do not dispose of the batteries in a fire as they may explode.

Air Conditioner Remote Control

The functions work the same as your air conditioner's touch controls.
All key function can be accessed from the remote control.

CONTROL PANEL

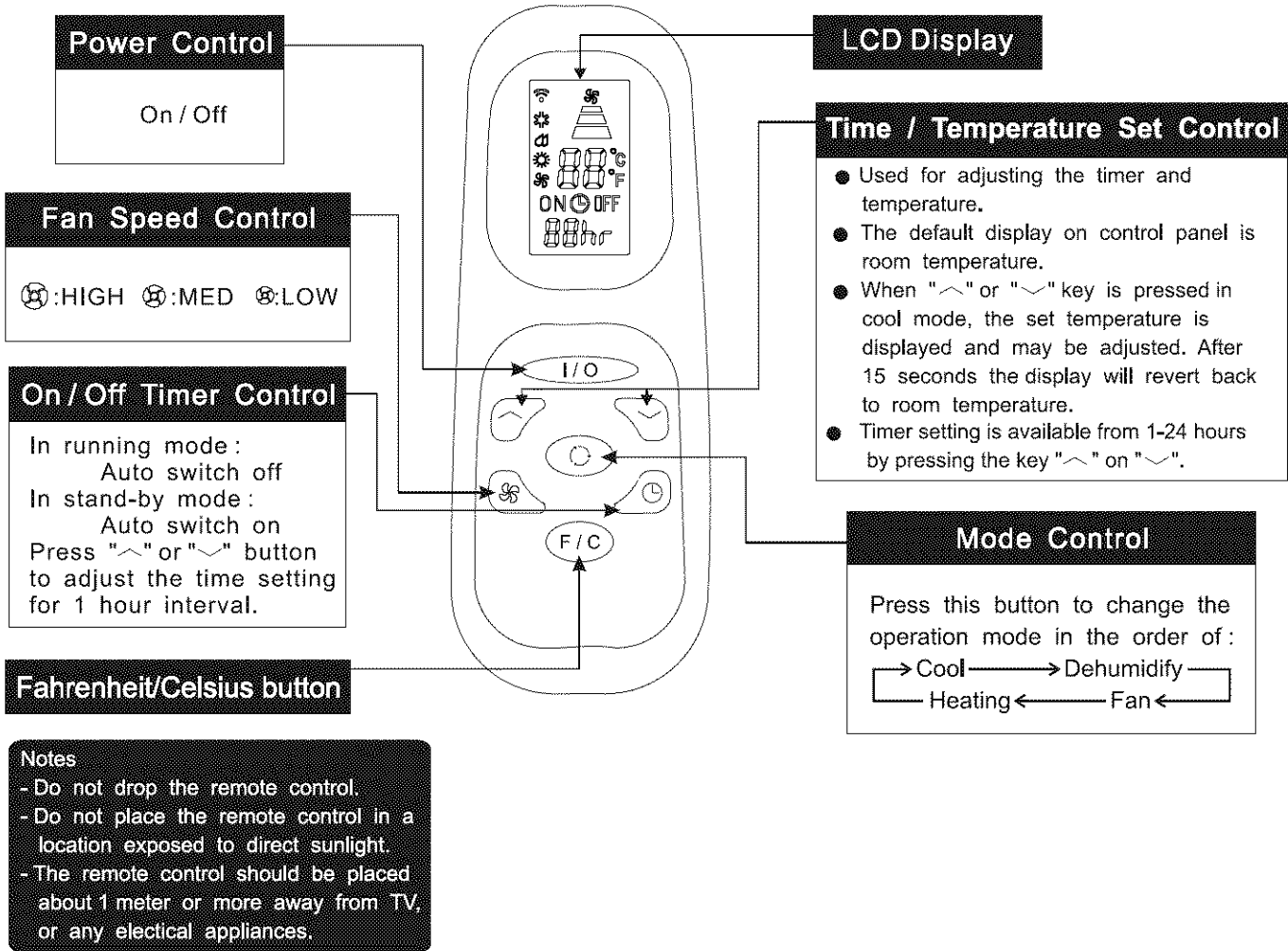

Battery replacement : Remove the cover on the back of the remote control and insert the batteries with the (+) and (-) poles pointing in the proper direction.

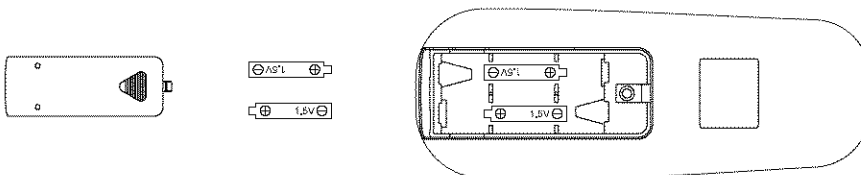

CAUTION

- Use only AAA or IEC R03 1.5V batteries.
- Remove the batteries if the remote control is not used for a month or longer.
- Do not attempt to recharge the supplied batteries.
- All batteries should be replaced at the same time, do not mix old battery .
- Do not dispose of the batteries in a fire as they may explode.

TECHNICAL SPECIFICATIONS

AIR CONDITIONER

ITEM	UNIT	WAP-267DA	
OUTER DIMENSION	mm	435W*770H*430D	
REFERENTIAL USING AREA	m ²	13~19	
RATED VOLTAGE	V/Hz	115 / 60	
COOLING CAPACITY	B.T.U.	9000	
DEHUMIDIFYING CAPACITY	L/H	1.6	
RUNNING CURRENT	A	8.0	
POWER CONSUMPTION	W	900	
INDOOR AIR VOLUME	M ³ /hr	320	
COMPRESSOR	MODEL	2R12S3R126A	
	INPUT POWER	W	740
	OPERATING CYCLE	uF/V	35/250
	PROTECTOR		MRA98503 or MRA98706 or MRA98706-9090
	LOCKED ROTOR AMPS	A	6.9
INDOOR MOTOR	MODEL	LS-16T3-02	
	OUTPUT POWER	W	16
	OPERATING CYCLE	uF/V	4.0/250
OUTDOOR MOTOR	MODEL	LS-53T1-4P	
	OUTPUT POWER	W	40
	OPERATING CYCLE	uF/V	9.0/250
TURBINE FAN MOTOR	MODEL	WT-15T1-03	
	OUTPUT POWER	W	2
CAPILLARY	mm	2.6(O.D.)*1.6(I.D.)*1000(L)	
EVAPORATOR		2R12S15FPI	
CONDENSER		2R16S21FPI	
REFRIGERANT	R-22/g	400	
WEIGHT	Kg	29	

TECHNICAL SPECIFICATIONS

AIR CONDITIONER

ITEM	UNIT	WAP-267DAH	
OUTER DIMENSION	mm	435W*770H*430D	
REFERENTIAL USING AREA	m ²	13~19	
RATED VOLTAGE	V/Hz	115 / 60	
CAPACITY(Cooling/Heating)	KW	2.6 / 2.6	
DEHUMIDIFYING CAPACITY	L/H	1.6	
CURRENT(Cooling/Heating)	A	8.0 / 8.0	
POWER CONSUMPTION (Cooling/Heating)	W	900 / 900	
INDOOR AIR VOLUME	M ³ /hr	320	
COMPRESSOR	MODEL	2R12S3R126A	
	INPUT POWER	W	740
	OPERATING CYCLE	uF/V	35/250
	PROTECTOR		MRA98503 or MRA98706 or MRA98706-9090
	LOCKED ROTOR AMPS	A	6.9
INDOOR MOTOR	MODEL	LS-16T3-02	
	OUTPUT POWER	W	16
	OPERATING CYCLE	uF/V	4.0/250
OUTDOOR MOTOR	MODEL	LS-53T1-4P	
	OUTPUT POWER	W	40
	OPERATING CYCLE	uF/V	9.0/250
TURBINE FAN MOTOR	MODEL	WT-15T1-03	
	OUTPUT POWER	W	2
CAPILLARY	mm	2.6(O.D.)*1.6(I.D.)*1000(L)	
EVAPORATOR		3R12S15FPI	
CONDENSER		3R16S17FPI	
REFRIGERANT	R-22/g	460	
WEIGHT	Kg	30	

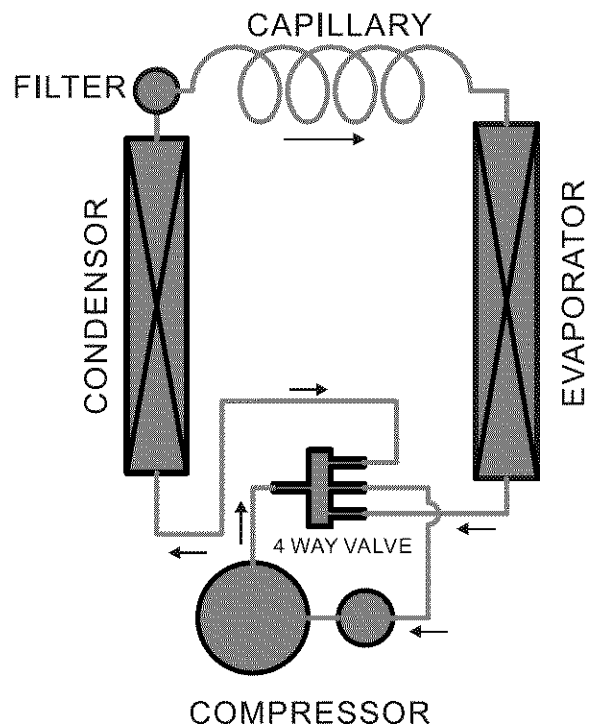
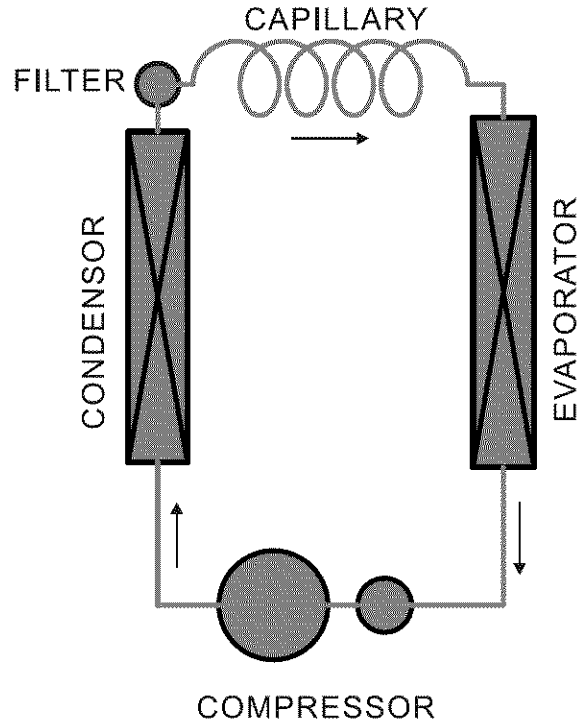

SCHEMATIC WIRING DIAGRAM

WAP-267DA

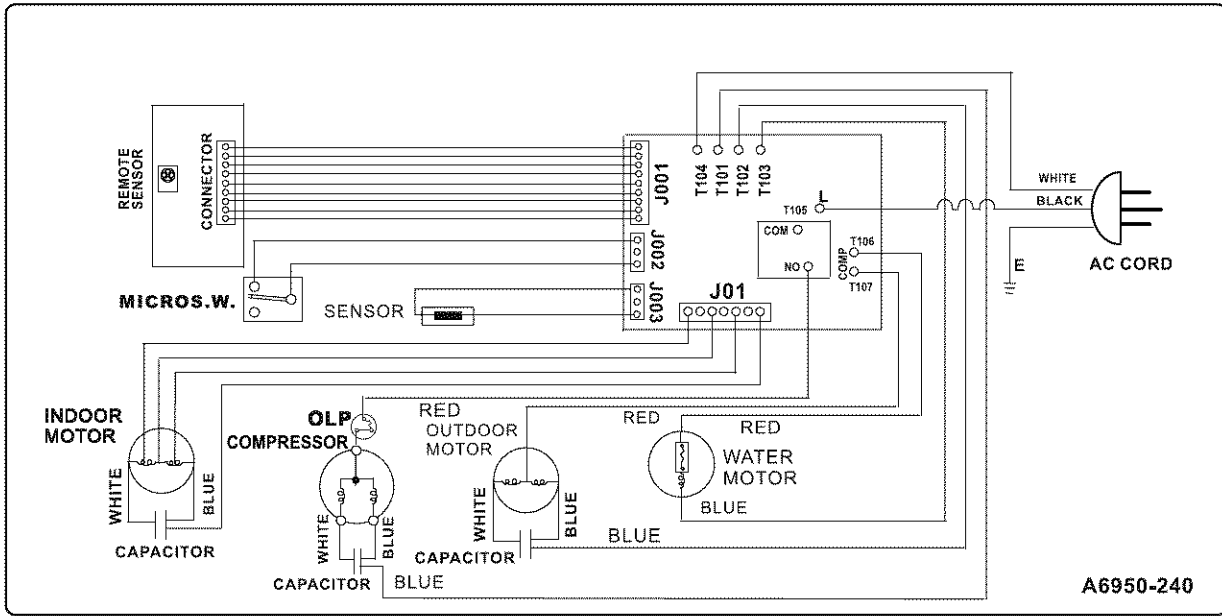

SCHEMATIC WIRING DIAGRAM

WAP-267DAH

